

## Specification Guide

# B Series

## Multi-Position & Hydronic Air Handlers

Electric or Hot Water Heat, with available Variable-Speed High Efficiency ECM Motor



<b>Contents</b>	<b>Page</b>
Product Features	2
Physical Data	3
Nomenclature	4
Blower Performance	5
Electrical Data	8
Water Heating Capacities	12
Hydronic System Design	14
Line Lengths for Heating Coils	15
Installation Configurations	16
Dimensions	18



Product improvement is a continuous process at Advanced Distributor Products. Therefore, product specifications are subject to change without notice and without obligation on our part. Please contact your ADP representative or distributor to verify details.

© by **Advanced Distributor Products**. All rights reserved.

## Cabinet and General Features

- Enhanced grommets - secure & tight.
- Multi-position available from factory, or field convertible with accessory kit.
- Side return right- or left-hand capable on 12-30, 36 size models.
- All air handlers are basiloid packaged with bar coding and full description on label.
- Filter rack door with thumb screws for easy access and replacement.
- Fiberglass air filter comes with every air handler and filter racks accepts readily available size filters.
- Cabinet constructed of heavy gauge painted steel.
- High quality 5/8" foil-faced insulation lines cabinet.
- UL lab tested 2% or less cabinet air leakage for better efficiency.
- Approved for installation in manufactured housing and mobile homes.

## Evaporator Coil Features

- Lanced fin design and internally enhanced copper tubing.
- Suitable for use with R-22 and R-410A.
- Dual 3/4" FPT left and right condensate drain connections.
- Drain pans are molded of corrosion proof high temperature (450°F) engineering polymer.
- Coils are air pressure tested at 500 PSI, pressure tested with helium, sealed and then charged with dry air.
- Piston, A/C TXV, or HP TXV available factory installed. Screw-on TXVs available as kits for field installation (see Accessories & Replacement Parts list for available kits).

## Hot Water Heat Features

- Hot water heat kits available both factory and field installed.
- Easy to replace hot water coil. Remove one screw and slide out.
- Suitable for potable water systems and certified to NSF 372.
- Optional factory installed circulating pump fully encased in cabinet (includes integral check valve).
- Optional factory installed 130 deg F aquastat delays water circulation until hot.
- Purge valve on hot water coil allows for manual release of any air trapped in coil during installation or servicing.
- Water connections 7/8" ODF (for 3/4" water pipe) on 12 - 30, & 36 size models and 1 1/8" ODF (for 1" water pipe) on 31, & 37 - 60 size models.
- Control board comes standard factory installed on all Air Handlers and includes the following features:  
(Features are compatible with both factory and field installed circulating pumps.)
  1. Pump timer- Activates pump for 1 minute every 6 hours eliminating stagnant water in hot water coil (meets Massachusetts requirements).
  2. 24 VAC isolation valve control-allows for zoning control.
  3. Auxiliary contacts for water heater or boiler activation.
  4. Freeze protection- standard factory installed, activates at 40 deg. F and deactivates at 70 deg. F.
  5. Thermostat connections.
  6. Time delay for blower activation:
    - 60 seconds (std.)
    - 130 deg. F Aquastat (w/optional aquastat)

## Variable-Speed High Efficiency ECM Motor Features

- Variable-speed control board includes dry contacts for thermostat connections.
- Constant air circulation feature runs airflow at 50% of cooling CFM, improves IAQ and eliminates stratification.
- Control board LED Lights display operation mode and when dehumidification is activated.
- Dehumidification - cutting dehumidification resistor on variable-speed control board reduces cooling airflow by 10%.
- Choose your own cooling/heating airflow settings, by selecting taps A-D on the variable-speed control board.
- Fine tune your airflow setting by selecting (+) tap to increase airflow by 10% and (-) tap to decrease airflow by 12%.
- Soft start feature runs airflow at 82% of cooling CFM for first 7.5 minutes of operation.
- Time delay- 1 minute blower off delay at the end of a call for cooling.

## Electrical Features

- Blower door safety switch on all models.
- Dynamically balanced high efficiency three-speed motors for project flexibility.
- Easy to adjust blower speeds for fine tuning customer comfort.
- Electrical connections can be made on top or both sides of cabinet.
- Electric heat kits available factory installed for 2.5 & 5 kW. Higher kW heat kits available for field installation.

# Physical Data

		Unit Size										
		12	18	24	25	30	31	36	37	42	48	60
<b>Transformer Size and Type</b>		40VA, Class 2										
<b>Blower Data:</b> 3-Speed Motor (120 V)	<b>Available Voltage</b> <sup>[1]</sup>	(120 V, 60 Hz, 1 ph.)										
	<b>Wheel (dia." x width")</b>	9 X 6				10 X 8						10 x 10
	<b>Motor H. P.</b>	1/3	1/3	1/3	1/3	1/3	1/3	1/3	1/3	1/2	3/4	3/4
	<b>F. L. A. @ 120 V</b>	2	3.2	3.2	5.3	5.3	7.1	7.1	7.1	8.5	7.5	10.5
	<b>Nominal CFM</b>	400	600	800	800	1000	1000	1200	1200	1400	1600	2000
<b>Blower Data:</b> 3-Speed Motor (240 V)	<b>Available Voltage</b> <sup>[1]</sup>	(208/240 V, 60 Hz, 1 ph.) or (220 V, 50 Hz, 1 ph.)										
	<b>Wheel (dia." x width")</b>	9 X 6				10 X 8				11 X 8		12 X 9
	<b>Motor H. P.</b>	1/3	1/3	1/3	1/3	1/3	1/3	1/3	1/3	1/3	1/2	1/2
	<b>F. L. A. @ 240 V</b>	1.8	1.8	1.8	1.9	1.9	2.6	2.6	1.9	1.9	3.9	3.9
	<b>Nominal CFM</b>	400	600	800	800	1000	1000	1200	1200	1400	1600	2000
<b>Blower Data:</b> Variable-Speed High Efficiency ECM Motor	<b>Available Voltage</b> <sup>[1]</sup>	-	-	-	120 V or 208/240 V, 60 Hz, 1 ph.			-	120 V or 208/240 V, 60 Hz, 1 ph.			
	<b>Wheel (dia." x width")</b>	-	-	-	9 X 6	10 X 8	10 X 8	-	10 X 8	10 X 8	10 X 8	10 X 10
	<b>Motor H. P.</b>	-	-	-	1/3	1/2	1/2	-	1/2	3/4	3/4	3/4
	<b>F. L. A. @ 120 V</b>	-	-	-	4.8	5.4	5.4	-	5.4	7.0	7.0	8.6
	<b>F. L. A. @ 240 V</b>	-	-	-	2.4	2.7	2.7	-	2.7	3.5	3.5	4.3
	<b>Cooling CFM Range</b>	-	-	-	600 - 1000	600 - 1200	600 - 1200	-	600 - 1200	1000 - 1600	1000 - 1600	1200 - 1850
	<b>Heating CFM Range</b>	-	-	-	600 - 1000	1100 - 1200	1100 - 1200	-	1100 - 1200	1100 - 1600	1100 - 1600	1200 - 1850
<b>Single-Speed Circulating Pump Data</b>	<b>Pump Connection Size</b>	7/8"										
	<b>Voltage</b>	120 V or 208/240 V										
	<b>Amps</b>	0.57 @ 120V or 0.28 @ 240V										
<b>Air Filter Size (in)</b>	12 X 20			16 X 20		16 X 24	16 X 20	16 X 24			18 X 24	
<b>Sound Level @ 0.3 Static (dBA)</b> <sup>[2]</sup>	46	46	51	52	54	56	52	56	55	55	55	
<b>Refrigerant Conn. (IDS) Suction</b>	3/4"						7/8"	3/4"	7/8"			
<b>Refrigerant Conn. (IDS) Liquid</b>	3/8"											
<b>R-22 Florator Piston Size (in)</b>	.041	.053	.059	.059	.067	.067	.073	.073	.080	.084	.093	
<b>R-410A Florator Piston Size (in)</b>	.041	.049	.053	.053	.059	.059	.067	.067	.073	.076	.093	
<b>Weight lbs. (base unit w/out hot water coil)</b>	120	120	120	130	140	150	140	150	210	230	240	

[1] Electric heat models not available in 120 V, 60 Hz.

[2] Typical sound levels based on 240V 3-speed PSC motor.

# Product Nomenclature

	<b>B</b>	<b>C</b>	<b>R</b>	<b>M</b>	<b>A3</b>	<b>9</b>	<b>24</b>	<b>S</b>	<b>3P</b>	<b>3</b>																									
<p><b>Series</b>  <b>B</b> = Painted cabinet (taupe)</p> <hr/> <p><b>Blower Motor</b>  <b>C</b> = 3-speed PSC motor  <b>V</b> = Variable-speed high-efficiency ECM motor <sup>[1]</sup></p> <hr/> <p><b>Horizontal Drain Pan Position</b><sup>[2]</sup>  <b>R</b> = Right-hand  <b>O</b> = No cooling coil</p> <hr/> <p><b>Airflow Configuration</b>  <b>V</b> = Vertical only <sup>[2]</sup>  <b>M</b> = Multi-position <sup>[3]</sup></p> <hr/> <p><b>Slab Number</b></p> <hr/> <p><b>Metering Device</b> <sup>[4]</sup>  <b>0</b> = No cooling coil  <b>1</b> = Piston (R-410A)  <b>2</b> = Piston (R-22)  <b>6</b> = Non-Bleed A/C TXV (R-410A)  <b>7</b> = Bleed HP-A/C TXV (R-410A)  <b>8</b> = Bleed A/C TXV (R-410A)  <b>9</b> = Non-Bleed HP-A/C TXV (R-410A)</p> <hr/> <p><b>Unit Size</b> (Nominal MBTUH)  12, 18, 24, 25, 30, 36   31, 37, 42, 48, 60  Slant Coil (side return capable)   "A" Coil</p>											<p><b>Voltage</b> (All include time delay functionality)  <b>1</b> = 208/240V, 60 Hz, 1 ph.  <b>3</b> = 120V, 60 Hz, 1 ph. <sup>[5]</sup>  <b>4</b> = 120V, 60 Hz, 1 ph. &amp; 130°F aquastat <sup>[5]</sup></p> <hr/> <p><b>Electric Heat</b> <sup>[5] [6]</sup>  <b>00</b> = No heat  <b>02</b> = 2.5 kW electric  <b>05</b> = 5 kW electric</p> <hr/> <p><b>Hot Water Coil with Pump &amp; Valve Assembly</b>  <b>2P</b> = 2 row hot water coil [sizes 12-30,36]  <b>3P</b> = 3 row hot water coil [all sizes]  <b>4P</b> = 4 row hot water coil [sizes 31,37-60]</p> <hr/> <p><b>Hot Water Coil without Pump &amp; Valve Assembly</b>  <b>2N</b> = 2 row hot water coil [sizes 12-30,36]  <b>3N</b> = 3 row hot water coil [all sizes]  <b>4N</b> = 4 row hot water coil [sizes 31,37-60]</p> <hr/> <p><b>Line Voltage Connection</b></p> <table border="1" style="margin-left: auto; margin-right: auto;"> <thead> <tr> <th rowspan="2"></th> <th colspan="4">Amount of Heat (kW)</th> </tr> <tr> <th>0 kW</th> <th>2.5 kW</th> <th>5 kW</th> <th>Hot Water</th> </tr> </thead> <tbody> <tr> <td><b>S</b> = Stripped Wire</td> <td>#</td> <td></td> <td>#</td> <td>#</td> </tr> <tr> <td><b>T</b> = Terminal Block</td> <td></td> <td>#</td> <td>O</td> <td></td> </tr> <tr> <td><b>B</b> = Circuit Breaker</td> <td></td> <td></td> <td>O</td> <td></td> </tr> </tbody> </table> <p style="text-align: center;"># = Standard    O = Optional</p>		Amount of Heat (kW)				0 kW	2.5 kW	5 kW	Hot Water	<b>S</b> = Stripped Wire	#		#	#	<b>T</b> = Terminal Block		#	O		<b>B</b> = Circuit Breaker			O	
	Amount of Heat (kW)																																		
	0 kW	2.5 kW	5 kW	Hot Water																															
<b>S</b> = Stripped Wire	#		#	#																															
<b>T</b> = Terminal Block		#	O																																
<b>B</b> = Circuit Breaker			O																																

[1] Variable-speed motor option not available in some unit sizes and some slab numbers; see price sheet for availability.

[2] Horizontal drain pans can be field installed as an accessory in vertical only air handlers for multi-position configuration.

[3] Multi-position air handlers will have factory installed horizontal drain pan on right side.

[4] 7 and 8 valve options available only for York family products.

[5] Electric heat models not available in 120V, 60 Hz.

[6] Electric heat kits higher than 5 kW only available as field installed kits.

**Notes:** Horizontal Drain Pan Position for slant coil models indicate that the opposing side of the cabinet is side air return capable. All Air Handlers with slant coils can be field converted to allow for either left or right side air return. Approved in Commonwealth of Massachusetts.

# Blower Performance: 3 Speed Motor (208/240 V Motor)

All data is given while air handler is operating with a dry DX coil and air filter installed.

Speeds marked in **bold with asterisk\*** are the factory speed settings for both heating and cooling.

Heating speeds should not be reduced below factory setting.

Unit Size (MBTUH)	Fan Speed Setting	Airflow (CFM) vs. External Static Pressure (inches W.C.)									
		Electric Heat Models					Water Heat Models				
		0.10	0.20	0.30	0.40	0.50	0.10	0.20	0.30	0.40	0.50
12	<b>*Low</b>	640	635	619	584	513	608	603	588	555	487
	Med	907	861	808	743	659	862	818	768	706	626
	High	961	914	854	786	703	913	868	811	747	668
18	<b>*Low</b>	640	635	619	584	513	608	603	588	555	487
	Med	907	861	808	743	659	862	818	768	706	626
	High	961	914	854	786	703	913	868	811	747	668
24	Low	640	635	619	584	513	608	603	588	555	487
	Med	907	861	808	743	659	862	818	768	706	626
	<b>*High</b>	961	914	854	786	703	913	868	811	747	668
25	Low	757	725	673	602	549	719	689	639	572	522
	<b>*Med</b>	893	862	823	746	660	848	819	782	709	627
	High	1111	1059	1005	964	904	1055	1006	955	916	859
30	Low	757	725	673	602	549	719	689	639	572	522
	Med	893	862	823	746	660	848	819	782	709	627
	<b>*High</b>	1111	1059	1005	964	904	1055	1006	955	916	859
31	<b>*Low</b>	1221	1187	1099	1080	1018	1160	1128	1044	1026	967
	Med	1329	1267	1208	1146	1073	1263	1204	1148	1089	1019
	High	1383	1317	1260	1188	1103	1314	1251	1197	1129	1048
36	Low	1221	1187	1099	1080	1018	1160	1128	1044	1026	967
	<b>*Med</b>	1329	1267	1208	1146	1073	1263	1204	1148	1089	1019
	High	1383	1317	1260	1188	1103	1314	1251	1197	1129	1048
37	<b>*Low</b>	1251	1263	1253	1214	1133	1188	1200	1190	1153	1076
	Med	1396	1397	1371	1309	1215	1326	1327	1302	1244	1154
	High	1731	1668	1588	1487	1379	1644	1585	1509	1413	1310
42	Low	1251	1263	1253	1214	1133	1188	1200	1190	1153	1076
	<b>*Med</b>	1396	1397	1371	1309	1215	1326	1327	1302	1244	1154
	High	1731	1668	1588	1487	1379	1644	1585	1509	1413	1310
48	Low	1627	1582	1513	1432	1328	1546	1503	1437	1360	1262
	<b>*Med</b>	1801	1706	1620	1513	1398	1711	1621	1539	1437	1328
	High	1854	1748	1656	1552	1448	1761	1661	1573	1474	1376
60	Low	1640	1583	1552	1497	1439	1558	1504	1474	1422	1367
	<b>*Med</b>	1961	1892	1814	1704	1616	1863	1797	1723	1619	1535
	High	2072	2001	1889	1789	1643	1968	1901	1795	1700	1561

# Blower Performance: 3 Speed Motor (120 V Motor)

All data is given while air handler is operating with a dry DX coil and air filter installed.  
 Speeds marked in **bold with asterisk\*** are the factory speed settings for both heating and cooling.  
 Heating speeds should not be reduced below factory setting.

Unit Size (MBTUH)	Fan Speed Setting	Airflow (CFM) vs. External Static Pressure (inches W.C.)									
		No Heat Models					Water Heat Models				
		0.10	0.20	0.30	0.40	0.50	0.10	0.20	0.30	0.40	0.50
12	<b>*Low</b>	499	493	470	437	401	458	445	431	402	368
	Med	671	636	611	557	490	631	611	581	543	485
	High	727	715	675	631	540	725	691	650	602	544
18	Low	499	493	470	437	401	458	445	431	402	368
	<b>*Med</b>	671	636	611	557	490	631	611	581	543	485
	High	727	715	675	631	540	725	691	650	602	544
24	Low	687	584	579	549	487	588	580	564	537	471
	<b>*Med</b>	889	847	795	731	666	771	747	710	671	600
	High	952	896	847	780	697	893	848	801	714	639
25	<b>*Low</b>	819	812	805	782	735	781	777	773	760	741
	Med	1015	1004	986	961	930	989	989	983	967	942
	High	1155	1149	1122	1090	1039	1095	1089	1072	1049	1020
30	Low	819	812	805	782	735	781	777	773	760	741
	<b>*Med</b>	1015	1004	986	961	930	989	989	983	967	942
	High	1155	1149	1122	1090	1039	1095	1089	1072	1049	1020
31	<b>*Low</b>	1121	1110	1099	1065	1023	1118	1111	1097	1060	1013
	Med	1302	1278	1233	1197	1144	1275	1261	1222	1168	1112
	High	1448	1391	1359	1298	1223	1355	1330	1317	1267	1196
36	Low	1121	1110	1099	1065	1023	1118	1111	1097	1060	1013
	<b>*Med</b>	1302	1278	1233	1197	1144	1275	1261	1222	1168	1112
	High	1448	1391	1359	1298	1223	1355	1330	1317	1267	1196
37	Low	1190	1122	1052	1028	1003	1072	1011	947	926	903
	<b>*Med</b>	1437	1355	1270	1241	1212	1351	1274	1194	1167	1139
	High	1449	1429	1389	1344	1298	1361	1342	1305	1263	1219
42	Low	1345	1331	1302	1282	1257	1153	1144	1144	1135	1135
	<b>*Med</b>	1681	1615	1587	1521	1487	1494	1445	1431	1395	1342
	High	1788	1727	1674	1603	1529	1666	1590	1571	1511	1469
48	Low	1568	1527	1502	1433	1397	1518	1440	1409	1383	1338
	<b>*Med</b>	1775	1724	1672	1563	1505	1652	1575	1541	1506	1459
	High	1881	1834	1765	1693	1597	1736	1668	1614	1564	1524
60	Low	1662	1650	1643	1614	1568	1646	1642	1639	1630	1606
	<b>*Med</b>	1853	1840	1813	1746	1675	1833	1826	1820	1766	1702
	High	2085	2038	1990	1916	1839	2065	2029	1981	1918	1847

# Blower Performance: Variable-Speed High Efficiency ECM Motor

Unit Size (MBTUH)	Operating Mode	Thermostat Terminals						Control Board Taps							
		X = Energized Terminal						Cool				Heat			
		HUM	EM	W1	Y1	Y2	G	A	B	C	D	A	B	C	D
							CFM	CFM	CFM	CFM	CFM	CFM	CFM	CFM	CFM
25	Continuous Blower						X	500	400	350	350				
	Hi Cooling / HP Heating	**			X	X		1000	800	700	600				
	Low Cooling / HP Heating				X			700	560	490	420				
	Aux. Heat			X	X	X		***	***	***	***	1000	800	700*	600*
	Emer. Heat		X	X				***	***	***	***	1000	800	700*	600*
30, 31	Continuous Blower						X	600	500	400	350				
	Hi Cooling / HP Heating	**			X	X		1200	1000	800	600				
	Low Cooling / HP Heating				X			840	700	560	420				
	Aux. Heat			X	X	X		***	***	***	***	1200	1100	1100	1100
	Emer. Heat		X	X				***	***	***	***	1200	1100	1100	1100
37	Continuous Blower						X	600	500	400	350				
	Hi Cooling / HP Heating	**			X	X		1200	1000	800	600				
	Low Cooling / HP Heating				X			840	700	560	420				
	Aux. Heat			X	X	X		***	***	***	***	1200	1100*	1100*	1100*
	Emer. Heat		X	X				***	***	***	***	1200	1100*	1100*	1100*
42	Continuous Blower						X	800	700	600	500				
	Hi Cooling / HP Heating	**			X	X		1600	1400	1200	1000				
	Low Cooling / HP Heating				X			1120	980	840	700				
	Aux. Heat			X	X	X		***	***	***	***	1600	1400	1200*	1100*
	Emer. Heat		X	X				***	***	***	***	1600	1400	1200*	1100*
48	Continuous Blower						X	800	700	600	500				
	Hi Cooling / HP Heating	**			X	X		1600	1400	1200	1000				
	Low Cooling / HP Heating				X			1120	980	840	700				
	Aux. Heat			X	X	X		***	***	***	***	1600	1400*	1200*	1100*
	Emer. Heat		X	X				***	***	***	***	1600	1400*	1200*	1100*
60	Continuous Blower						X	900	800	700	600				
	Hi Cooling / HP Heating	**			X	X		1850	1600	1400	1200				
	Low Cooling / HP Heating				X			1295	1120	980	840				
	Aux. Heat			X	X	X		***	***	***	***	1850	1600	1400*	1200*
	Emer. Heat		X	X				***	***	***	***	1850	1600	1400*	1200*

\* This CFM is not approved for use with the highest kW heater size.

\*\* Humidistat will reduce cooling airflow by 10% in high humidity.

\*\*\*Airflow is the greater of the COOL and HEAT values when both electric heat and heat pump are operating.

Adjust tap (+) will increase airflow by 10%, while tap (-) will decrease airflow by 12%.

Adjust tap TEST will cause the motor to run at 70% of full airflow. Use this for troubleshooting only.

At the start of a call for cooling there is a short run at 82% of airflow for 7.5 minutes.

At the end of a call for cooling there is a blower off delay of 1 minute.

Note: CFM performance remains constant up to 0.8" ext. static pressure; above 0.8" will result in loss of performance.

**Special Note for Units Equipped with Humidistat:** If using a humidistat, the Dehumidify resistor located on the bottom right of the control board must be removed. The HUM terminal on the board must be connected to the Normally Closed contact of the humidistat so that the board senses an open circuit on high humidity.

Control Board Taps and Dehumidify Resistor.

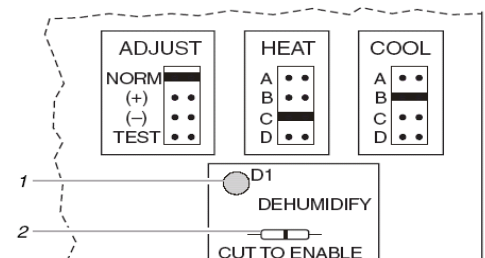

1. Dehumidify LED
2. Dehumidify resistor

The motor control board that provides airflow selection also features LED indicators that display operating mode, humidity control, and airflow CFM. In addition, thermostat signals for emergency heat (EM), aux. heat (W1), reversing valve (O), compressor stage 1 (Y1), compressor stage 2 (Y2), and blower (G) are all indicated by lit LED's on this board. If a humidistat is used, the dehumidify LED will light when the humidistat opens and the motor runs at reduced airflow. The control board also has a CFM LED that displays the operating CFM. This red LED flashes once for each 100 CFM. For example, if the operating CFM is 1200, the CFM LED will flash 12 times, then pause before repeating the 12-flash pattern.

# Electrical Data: 3-Speed PSC Motor

## With Water Heat or No Heat

Unit Size (MBTUH)	Electric Heating Capacity		3-Speed Blower Minimum Heat Setting	Blower Amps			Min Circuit Ampacity			Circuit Breaker Amps Per Stage		
	kW	BTUH		3-Speed Blower			3-Speed Blower					
				240 V <sup>[1]</sup>	240 V <sup>[1]</sup>	120V	208V	240V	120V	208V	240V	1
12	0	0	Low	2.0	1.9	1.8	2.5	2.4	2.3	15	--	--
18	0	0	Low	3.2	1.9	1.8	4.0	2.4	2.3	15	--	--
24	0	0	Low	3.2	1.9	1.8	4.0	2.4	2.3	15	--	--
25	0	0	Low	5.3	2.1	1.9	6.6	2.6	2.4	15	--	--
30	0	0	Low	5.3	2.1	1.9	6.6	2.6	2.4	15	--	--
31	0	0	Low	7.1	2.8	2.6	8.9	3.5	3.3	15	--	--
36	0	0	Low	7.1	2.8	2.6	8.9	3.5	3.3	15	--	--
37	0	0	Low	7.1	2.1	1.9	8.9	2.6	2.4	15	--	--
42	0	0	Low	8.5	2.1	1.9	10.6	2.6	2.4	15	--	--
48	0	0	Low	7.5	4.2	3.9	9.4	5.3	4.9	15	--	--
60	0	0	Low	10.5	4.2	3.9	13.1	5.3	4.9	15	--	--

## With Electric Heat

Unit Size (MBTUH)	Electric Heating Capacity		3-Speed Blower Minimum Heat Setting	Blower Amps		Min Circuit Ampacity		Circuit Breaker Amps Per Stage <sup>[2]</sup>		
	kW	BTUH		3-Speed Blower		3-Speed Blower				
				240 V <sup>[1]</sup>	240 V <sup>[1]</sup>	208V	240V	208V	240V	1
12	2.5	8,530	Low	1.9	1.8	13.7	15.3	20	--	--
	5	17,065	Low	1.9	1.8	24.9	28.3	30	--	--
18	2.5	8,530	Low	1.9	1.8	13.7	15.3	20	--	--
	5	17,065	Low	1.9	1.8	24.9	28.3	30	--	--
	7.5	25,598	Med	1.9	1.8	36.2	41.3	45	--	--
10	34,130	Med	1.9	1.8	47.5	54.3	60	--	--	
24	2.5	8,530	Low	1.9	1.8	13.7	15.3	20	--	--
	5	17,065	Low	1.9	1.8	24.9	28.3	30	--	--
	7.5	25,598	Low	1.9	1.8	36.2	41.3	45	--	--
	10	34,130	Med	1.9	1.8	47.5	54.3	60	--	--
	<b>12.5</b>	<b>42,663</b>	Med	1.9	1.8	58.8	67.4	45	30	--
25	2.5	8,530	Low	2.1	1.9	13.9	15.4	20	--	--
	5	17,065	Low	2.1	1.9	25.2	28.4	30	--	--
	7.5	25,598	Low	2.1	1.9	36.5	41.4	45	--	--
	10	34,130	Low	2.1	1.9	47.8	54.5	60	--	--
	<b>12.5</b>	<b>42,663</b>	Low	2.1	1.9	59.0	67.5	45	30	--
	<b>15</b>	<b>51,195</b>	Low	2.1	1.9	70.3	80.5	60	30	--
30	2.5	8,530	Low	2.1	1.9	13.9	15.4	20	--	--
	5	17,065	Low	2.1	1.9	25.2	28.4	30	--	--
	7.5	25,598	Low	2.1	1.9	36.5	41.4	45	--	--
	10	34,130	Low	2.1	1.9	47.8	54.5	60	--	--
	<b>12.5</b>	<b>42,663</b>	Low	2.1	1.9	59.0	67.5	45	30	--
	<b>15</b>	<b>51,195</b>	Low	2.1	1.9	70.3	80.5	60	30	--
	<b>17.5</b>	<b>59,728</b>	Med	2.1	1.9	81.6	93.5	60	45	--

kW packages in **bold italics** indicate that these heat packages require and include circuit breakers. Optional for others.

[1] For 208 Volts use .751 correction factor for kW & BTUH.

[2] Listed circuit breaker size is for 240V applications. For 208V verify breaker sizing based on min. circuit ampacity.



# Electrical Data: 3-Speed PSC Motor

## With Electric Heat

Unit Size (MBTUH)	Electric Heating Capacity		3-Speed Blower Minimum Heat Setting	Blower Amps		Min Circuit Ampacity		Circuit Breaker Amps Per Stage <sup>[2]</sup>		
	kW	BTUH		3-Speed Blower		3-Speed Blower				
	240 V <sup>[1]</sup>	240 V <sup>[1]</sup>		208V	240V	208V	240V	1	2	3
31	2.5	8,530	Low	2.8	2.6	14.8	16.3	20	--	--
	5	17,065	Low	2.8	2.6	26.1	29.3	30	--	--
	7.5	25,598	Low	2.8	2.6	37.4	42.3	45	--	--
	10	34,130	Low	2.8	2.6	48.6	55.3	60	--	--
	<b>12.5</b>	42,663	Low	2.8	2.6	59.9	68.4	45	30	--
	<b>15</b>	51,195	Low	2.8	2.6	71.2	81.4	60	30	--
36	2.5	8,530	Low	2.8	2.6	14.8	16.3	20	--	--
	5	17,065	Low	2.8	2.6	26.1	29.3	30	--	--
	7.5	25,598	Low	2.8	2.6	37.4	42.3	45	--	--
	10	34,130	Low	2.8	2.6	48.6	55.3	60	--	--
	<b>12.5</b>	42,663	Med	2.8	2.6	59.9	68.4	45	30	--
	<b>15</b>	51,195	Med	2.8	2.6	71.2	81.4	60	30	--
	<b>17.5</b>	59,728	Med	2.8	2.6	82.5	94.4	60	45	--
	<b>20</b>	68,260	Med	2.8	2.6	93.8	107.4	60	60	--
37	5	17,065	Low	2.1	1.9	25.2	28.4	30	--	--
	7.5	25,598	Low	2.1	1.9	36.5	41.4	45	--	--
	10	34,130	Low	2.1	1.9	47.8	54.5	60	--	--
	<b>12.5</b>	42,663	Med	2.1	1.9	59.0	67.5	45	30	--
	<b>15</b>	51,195	Med	2.1	1.9	70.3	80.5	60	30	--
	<b>20</b>	68,260	Med	2.1	1.9	92.9	106.5	60	60	--
42	5	17,065	Low	2.1	1.9	25.2	28.4	30	--	--
	7.5	25,598	Low	2.1	1.9	36.5	41.4	45	--	--
	10	34,130	Low	2.1	1.9	47.8	54.5	60	--	--
	<b>12.5</b>	42,663	Low	2.1	1.9	59.0	67.5	45	30	--
	<b>15</b>	51,195	Med	2.1	1.9	70.3	80.5	60	30	--
	<b>20</b>	68,260	Med	2.1	1.9	92.9	106.5	60	60	--
48	5	17,065	Low	4.2	3.9	27.8	30.9	45 <sup>[3]</sup>	--	--
	7.5	25,598	Low	4.2	3.9	39.1	43.9	45	--	--
	10	34,130	Low	4.2	3.9	50.4	57.0	60	--	--
	<b>12.5</b>	42,663	Low	4.2	3.9	61.7	70.0	45	30	--
	<b>15</b>	51,195	Low	4.2	3.9	73.0	83.0	60	30	--
	<b>20</b>	68,260	Low	4.2	3.9	95.5	109.0	60	60	--
	<b>25</b>	85,325	Med	4.2	3.9	118.1	135.1	60	60	30
60	5	17,065	Low	4.2	3.9	27.8	30.9	45 <sup>[3]</sup>	--	--
	7.5	25,598	Low	4.2	3.9	39.1	43.9	45	--	--
	10	34,130	Low	4.2	3.9	50.4	57.0	60	--	--
	<b>12.5</b>	42,663	Low	4.2	3.9	61.7	70.0	45	30	--
	<b>15</b>	51,195	Low	4.2	3.9	73.0	83.0	60	30	--
	<b>20</b>	68,260	Low	4.2	3.9	95.5	109.0	60	60	--
	<b>25</b>	85,325	Med	4.2	3.9	118.1	135.1	60	60	30

kW packages in **bold italics** indicate that these heat packages require and include circuit breakers. Optional for others.

[1] For 208 Volts use .751 correction factor for kW & BTUH.

[2] Listed circuit breaker size is for 240V applications. For 208V verify breaker sizing based on min. circuit ampacity.

[3] Breaker supplied with heat kit may need to be changed. Verify breaker sizing based on min. circuit ampacity.

## Electrical Data: Variable Speed ECM Motor

### With Water Heat or No Heat

Unit Size (MBTUH)	Electric Heating Capacity		Blower Amps			Minimum Circuit Ampacity			Circuit Breaker Amps Per Stage		
	kW	BTUH	Variable-Speed ECM Blower			Variable-Speed ECM Blower					
	240 V <sup>[1]</sup>	240 V <sup>[1]</sup>	120V	208V	240V	120V	208V	240 V	1	2	3
25	0	0	4.8	2.6	2.4	6.0	3.3	3.0	15	--	--
30	0	0	5.4	2.9	2.7	6.8	3.6	3.4	15	--	--
31	0	0	5.4	2.9	2.7	6.8	3.6	3.4	15	--	--
37	0	0	5.4	2.9	2.7	6.8	3.6	3.4	15	--	--
42	0	0	7.0	3.7	3.5	8.8	4.6	4.4	15	--	--
48	0	0	7.0	3.7	3.5	8.8	4.6	4.4	15	--	--
60	0	0	8.6	4.6	4.3	10.8	5.8	5.4	15	--	--

### With Electric Heat

Unit Size (MBTUH)	Electric Heating Capacity		Blower Amps		Min Circuit Ampacity		Circuit Breaker Amps Per Stage <sup>[2]</sup>		
	kW	BTUH	Variable-Speed ECM Blower		Variable-Speed ECM Blower				
	240 V <sup>[1]</sup>	240 V <sup>[1]</sup>	208V	240V	208V	240 V	1	2	3
25	2.5	8,530	2.6	2.4	14.5	16.0	20	--	--
	5	17,065	2.6	2.4	25.8	29.0	30	--	--
	7.5	25,598	2.6	2.4	37.1	42.1	45	--	--
	10	34,130	2.6	2.4	48.4	55.1	60	--	--
	<b>12.5</b>	42,663	2.6	2.4	59.7	68.1	45	30	--
	<b>15</b>	51,195	2.6	2.4	71.0	81.1	60	30	--
30	2.5	8,530	2.9	2.7	14.9	16.4	20	--	--
	5	17,065	2.9	2.7	26.2	29.4	30	--	--
	7.5	25,598	2.9	2.7	37.5	42.4	45	--	--
	10	34,130	2.9	2.7	48.8	55.5	60	--	--
	<b>12.5</b>	42,663	2.9	2.7	60.0	68.5	45	30	--
	<b>15</b>	51,195	2.9	2.7	71.3	81.5	60	30	--
	<b>17.5</b>	59,728	2.9	2.7	82.6	94.5	60	45	--

kW packages in **bold italics** indicate that these heat packages require and include circuit breakers. Optional for others.

[1] For 208 Volts use .751 correction factor for kW & BTUH.

[2] Listed circuit breaker size is for 240V applications. For 208V verify breaker sizing based on min. circuit ampacity.

# Electrical Data: Variable Speed ECM Motor

## With Electric Heat

Unit Size (MBTUH)	Electric Heating Capacity		Blower Amps		Min Circuit Ampacity		Circuit Breaker Amps Per Stage <sup>[2]</sup>		
	kW	BTUH	Variable-Speed ECM Blower		Variable-Speed ECM Blower				
	240 V <sup>[1]</sup>	240 V <sup>[1]</sup>	208V	240V	208V	240V	1	2	3
31	2.5	8,530	2.9	2.7	14.9	16.4	20	--	--
	5	17,065	2.9	2.7	26.2	29.4	30	--	--
	7.5	25,598	2.9	2.7	37.5	42.4	45	--	--
	10	34,130	2.9	2.7	48.8	55.5	60	--	--
	<b>12.5</b>	42,663	2.9	2.7	60.0	68.5	45	30	--
	<b>15</b>	51,195	2.9	2.7	71.3	81.5	60	30	--
36 (not available)	2.5	8,530	--	--	--	--	--	--	--
	5	17,065	--	--	--	--	--	--	--
	7.5	25,598	--	--	--	--	--	--	--
	10	34,130	--	--	--	--	--	--	--
	<b>12.5</b>	42,663	--	--	--	--	--	--	--
	<b>15</b>	51,195	--	--	--	--	--	--	--
	<b>17.5</b>	59,728	--	--	--	--	--	--	--
	<b>20</b>	68,260	--	--	--	--	--	--	--
37	5	17,065	2.9	2.7	26.2	29.4	30	--	--
	7.5	25,598	2.9	2.7	37.5	42.4	45	--	--
	10	34,130	2.9	2.7	48.8	55.5	60	--	--
	<b>12.5</b>	42,663	2.9	2.7	60.0	68.5	45	30	--
	<b>15</b>	51,195	2.9	2.7	71.3	81.5	60	30	--
	<b>20</b>	68,260	2.9	2.7	93.9	107.5	60	60	--
42	5	17,065	3.7	3.5	27.2	30.4	35	--	--
	7.5	25,598	3.7	3.5	38.5	43.4	45	--	--
	10	34,130	3.7	3.5	49.8	56.5	60	--	--
	<b>12.5</b>	42,663	3.7	3.5	61.0	69.5	45	30	--
	<b>15</b>	51,195	3.7	3.5	72.3	82.5	60	30	--
	<b>20</b>	68,260	3.7	3.5	94.9	108.5	60	60	--
48	5	17,065	3.7	3.5	27.2	30.4	35 <sup>[3]</sup>	--	--
	7.5	25,598	3.7	3.5	38.5	43.4	45	--	--
	10	34,130	3.7	3.5	49.8	56.5	60	--	--
	<b>12.5</b>	42,663	3.7	3.5	61.0	69.5	45	30	--
	<b>15</b>	51,195	3.7	3.5	72.3	82.5	60	30	--
	<b>20</b>	68,260	3.7	3.5	94.9	108.5	60	60	--
	<b>25</b>	85,325	3.7	3.5	117.5	134.6	60	60	30
60	5	17,065	4.6	4.3	28.3	31.4	35 <sup>[3]</sup>	--	--
	7.5	25,598	4.6	4.3	39.6	44.4	45	--	--
	10	34,130	4.6	4.3	50.9	57.5	60	--	--
	<b>12.5</b>	42,663	4.6	4.3	62.2	70.5	45	30	--
	<b>15</b>	51,195	4.6	4.3	73.5	83.5	60	30	--
	<b>20</b>	68,260	4.6	4.3	96.0	109.5	60	60	--
	<b>25</b>	85,325	4.6	4.3	118.6	135.6	60	60	30

kW packages in **bold italics** indicate that these heat packages require and include circuit breakers. Optional for others.

[1] For 208 Volts use .751 correction factor for kW & BTUH.

[2] Listed circuit breaker size is for 240V applications. For 208V verify breaker sizing based on min. circuit ampacity.

[3] Breaker supplied with heat kit may need to be changed. Verify breaker sizing based on min. circuit ampacity.

# Water Heating Capacity (BTUH)

## Unit Sizes 12, 18 & 24

Water Coil Size	Entering Water Temp	1 GPM				2 GPM				3 GPM			
		H <sub>2</sub> O P.D. in FT.	CFM			H <sub>2</sub> O P.D. in FT.	CFM			H <sub>2</sub> O P.D. in FT.	CFM		
			400	600	800		400	600	800		400	600	800
2 ROW	120°F	0.2	9,004	10,979	11,914	0.6	11,639	13,997	15,683	1.4	12,536	15,396	17,522
	140°F	0.2	13,209	15,600	16,942	0.6	16,452	19,823	22,240	1.3	17,683	21,757	24,793
	160°F	0.2	17,628	20,302	22,065	0.6	21,316	25,727	28,834	1.3	22,872	28,184	32,151
	180°F	0.2	23,551	25,065	27,260	0.6	26,217	31,687	35,621	1.3	28,091	34,659	39,573
3 ROW	120°F	0.3	11,286	13,771	14,944	0.9	14,528	17,826	20,160	1.9	15,582	19,636	22,659
	140°F	0.2	16,401	19,506	21,177	0.9	20,495	25,194	28,524	1.9	21,942	27,701	32,004
	160°F	0.2	21,792	25,320	27,500	0.9	26,511	32,641	36,991	1.8	28,343	35,833	41,442
	180°F	0.2	26,908	31,193	33,891	0.9	32,564	40,145	45,532	1.8	34,771	44,014	50,947

## Unit Sizes 25, 30 & 36

Water Coil Size	Entering Water Temp	2 GPM				3 GPM				4 GPM			
		H <sub>2</sub> O P.D. in FT.	CFM			H <sub>2</sub> O P.D. in FT.	CFM			H <sub>2</sub> O P.D. in FT.	CFM		
			800	1000	1200		800	1000	1200		800	1000	1200
2 ROW	120°F	0.5	17,277	18,048	19,124	1.0	19,588	20,523	21,997	1.7	20,990	22,035	23,750
	140°F	0.5	24,529	25,619	27,164	1.0	27,747	29,072	31,155	1.7	29,682	31,163	33,616
	160°F	0.5	31,899	33,313	35,341	1.0	36,013	37,734	40,464	1.6	38,472	40,396	43,602
	180°F	0.4	39,359	41,098	43,622	0.9	44,360	46,482	49,872	1.6	47,332	49,705	53,678
3 ROW	120°F	0.7	21,309	22,783	26,216	1.4	24,501	26,156	28,137	2.4	25,648	28,187	30,578
	140°F	0.6	30,149	32,261	34,255	1.3	33,970	36,982	39,809	2.3	36,180	39,801	43,208
	160°F	0.6	39,095	41,866	44,472	1.3	43,988	47,928	51,621	2.2	46,799	51,526	55,970
	180°F	0.6	48,121	51,564	54,794	1.3	54,077	58,963	63,537	2.2	57,481	63,331	68,827

## Unit Sizes 31 & 37

Water Coil Size	Entering Water Temp	3 GPM				4 GPM				5 GPM			
		H <sub>2</sub> O P.D. in FT.	CFM			H <sub>2</sub> O P.D. in FT.	CFM			H <sub>2</sub> O P.D. in FT.	CFM		
			1000	1100	1200		1000	1100	1200		1000	1100	1200
3 ROW	120°F	0.8	28,726	29,931	31,014	1.4	31,055	32,522	33,856	2	32,602	34,260	35,779
	140°F	0.8	40,610	42,329	43,874	1.3	43,847	45,937	47,838	2	45,986	48,344	50,505
	160°F	0.8	52,624	54,869	56,888	1.3	56,759	59,485	61,965	1.9	59,479	62,550	65,366
	180°F	0.8	64,735	67,541	70,015	1.3	69,759	73,130	76,197	1.9	73,051	76,844	80,323
4 ROW	120°F	1.0	33,478	34,963	36,329	1.7	36,193	38,058	39,751	2.6	37,946	40,069	42,015
	140°F	1.0	47,246	49,386	51,301	1.7	51,024	53,674	56,080	2.6	53,450	56,462	59,224
	160°F	1.0	61,139	63,925	66,420	1.7	65,969	69,416	72,548	2.5	69,055	72,970	76,562
	180°F	1.0	75,121	78,563	81,645	1.6	80,995	82,250	89,117	2.4	84,734	89,561	93,993

All capacities are based on 70°F entering air temperature.

For entering air temperatures other than 70°F use the following capacity correction factors:

(72°F x .982), (68°F x 1.02), (66°F x 1.04).

Glycol correction factors: (10% X .98), (20% X .95), (30% X .92), (40% X .88).

# Water Heating Capacity (BTUH) (cont.)

## Unit Sizes 42 & 48

Water Coil Size	Entering Water Temp	3 GPM				4 GPM				5 GPM			
		H <sub>2</sub> O P.D. in FT.	CFM			H <sub>2</sub> O P.D. in FT.	CFM			H <sub>2</sub> O P.D. in FT.	CFM		
			1400	1500	1600		1400	1500	1600		1400	1500	1600
3 ROW	120°F	0.8	32,883	33,695	34,441	1.4	36,190	37,221	38,173	2.0	38,464	39,660	40,722
	140°F	0.8	46,541	47,701	48,766	1.3	51,167	52,686	53,996	2.0	54,329	56,032	57,617
	160°F	0.8	60,372	61,888	63,279	1.3	66,310	68,229	70,004	1.9	70,350	72,572	74,640
	180°F	0.9	74,330	76,209	77,933	1.3	81,575	83,951	86,149	1.9	86,486	89,234	91,792
4 ROW	120°F	1.0	38,636	39,631	40,540	1.7	42,707	44,006	45,204	2.6	45,457	46,988	48,409
	140°F	1.0	54,582	55,996	57,288	1.7	60,284	62,131	63,834	2.6	64,115	66,290	68,310
	160°F	1.0	70,692	72,535	74,216	1.7	78,023	80,428	82,647	2.5	82,925	85,756	88,386
	180°F	1.0	86,924	89,200	91,276	1.6	95,879	98,851	101,592	2.4	101,845	105,340	108,588

## Unit Size 60

Water Coil Size	Entering Water Temp	3 GPM				4 GPM				5 GPM			
		H <sub>2</sub> O P.D. in FT.	CFM			H <sub>2</sub> O P.D. in FT.	CFM			H <sub>2</sub> O P.D. in FT.	CFM		
			1800	1900	2000		1800	1900	2000		1800	1900	2000
3 ROW	120°F	1.2	37,308	37,936	38,521	2.1	41,636	42,459	43,229	3.2	44,672	45,650	46,570
	140°F	1.2	52,797	53,693	54,526	2.1	58,874	60,047	61,145	3.2	63,115	68,679	70,216
	160°F	1.2	68,481	69,650	70,737	2.0	76,308	77,839	79,273	3.1	81,747	83,564	85,273
	180°F	1.2	84,309	85,756	87,101	2.0	93,886	95,781	97,555	3.1	100,517	102,764	104,879
4 ROW	120°F	1.1	43,662	44,406	45,095	1.9	49,104	50,118	51,065	2.9	52,882	54,114	55,271
	140°F	1.1	61,666	62,721	63,698	1.9	69,318	70,759	72,104	2.8	74,605	76,356	77,999
	160°F	1.1	79,853	81,224	82,492	1.8	89,723	91,598	93,347	2.8	96,514	103,033	105,735
	180°F	1.1	98,172	99,863	101,427	1.8	110,265	112,579	114,739	2.7	118,557	121,369	124,009

All capacities are based on 70°F entering air temperature.

For entering air temperatures other than 70°F use the following capacity correction factors:

(72°F x .982), (68°F x 1.02), (66°F x 1.04).

Glycol correction factors: (10% X .98), (20% X .95), (30% X .92), (40% X .88).

# Hydronic System Design

Includes: Heating coil selection, line sizing and selected pump other than supplied by ADP

## Sample Application

3 ton Cooling Load  
 180° F Water Temp  
 40% Glycol Mixture  
 60,000 BTUH Heat Required

(1) From the 3 ton heating capacity tables select a hot water coil that supplies at least 60,000 btuh at 1,200 CFM, 180° F water temp.  
 The 3 row coil supplies 68,827 BTUH @ 4 GPM, 2.2' pressure drop  
 Correct capacity for 40% glycol (correction factors found below capacity chart)

	68,827
<b>Corrected coil heating capacity (BTUH)</b>	<b>X 0.88</b>
	<b>= 60,568</b>

(2) Determine total equivalent line length

Note: Use the following line sizes as a guide for initial selection

1 - 3 GPM, 3/4"	4 - 5 GPM, 1"	6 - 8 GPM, 1 1/4"
-----------------	---------------	-------------------

Line size	1"		Equiv. ft. of pipe (Table 3)			
Total number of fittings	Quantity			=		
90° SR elbows	20	X	2.7'	=	54'	54'
90° LR elbows	0	X	0	=	0	+ 0
45° elbows	0	X	0	=	0	+ 0
gate valves	2	X	1.9'	=	3.8'	+ 3.8'
Total supply and return line length						+ 186'
<b>Total equivalent line length</b>						<b>= 244'</b>

(3) Determine total pump head required

			Press. Drop/ft (Table 1)			
Total equivalent line length	244'	X	0.015	=	3.66	3.66'
Total pressure drop through coil (found on capacity chart)						+ 2.2'
Line length correction factor for 40% glycol @ 180°F (Table 2)						X 1.12
<b>Total pump head required</b>						<b>6.58'</b>

(4) Now select a pump that supplies 4 GPM with at least 6.58' head capability.

Note: If desired, recalculation can be done with another line size to vary pump requirement.

Note: Factory installed pumps are not approved for use with "on demand" or "Instantaneous" water heaters due to friction losses within the heat exchangers of tankless water heaters.

Nominal Pipe Size	GPM																	
	1	1.25	1.5	1.75	2	2.25	2.5	2.75	3	3.25	3.5	3.75	4	4.5	5	6	7	8
1/2"	.030	.048	.065	.083	.100	.125	.150	.175	.200	-	-	-	-	-	-	-	-	-
3/4"	.005	.009	.012	.016	.019	.024	.029	.034	.039	.045	.050	.056	.062	.077	.092	.130	-	-
1"	-	-	-	-	.005	.006	.007	.008	.009	.011	.012	.014	.015	.019	.023	.033	.042	.053
1 1/4"	-	-	-	-	-	-	-	-	-	-	-	-	.005	.007	.008	.011	.015	.018

% Glycol	140°F	160°F	180°F
10	1.04	1.04	1.02
20	1.08	1.07	1.04
30	1.13	1.11	1.08
40	1.19	1.16	1.12
50	1.24	1.21	1.17

Pipe Size	90° SR el	90° LR el	45° el	gate valve
1/2"	1.5	0.8	1	1
3/4"	2	1	1.4	1.4
1"	2.7	1.3	1.9	1.9
1 1/4"	3.6	1.8	2.5	2.5

# Maximum Line Lengths for Heating Coils Using ADP Pump

All line lengths are total for supply and return

Air Handler Size	Water Coil Size	Nominal	Maximum Supply Pipe Length (ft.) type K copper																				
		Pipe Size	GPM																				
		(ID)	1	1.3	1.5	1.8	2	2.3	2.5	2.8	3	3.3	3.5	3.8	4	4.3	4.5	4.8	5	6	7	8	
12, 18, & 24	2 Row	1/2"	256	149	100	71	53	35	23	15	8	-	-	-	-	-	-	-	-	-	-	-	
		3/4"	-	-	-	464	361	263	198	152	118	-	-	-	-	-	-	-	-	-	-	-	-
	3 Row	1/2"	256	148	98	70	51	33	20	12	5	-	-	-	-	-	-	-	-	-	-	-	
		3/4"	-	-	-	454	351	251	186	140	105	-	-	-	-	-	-	-	-	-	-	-	-
30 & 36	2 Row	1/2"	-	-	-	-	55	37	25	16	10	-	-	-	-	-	-	-	-	-	-	-	
		3/4"	-	-	-	-	372	273	208	162	128	99	76	58	43	-	-	-	-	-	-	-	-
		1"	-	-	-	-	-	-	-	-	-	504	401	321	257	-	-	-	-	-	-	-	-
	3 Row	1/2"	-	-	-	-	53	35	23	14	8	-	-	-	-	-	-	-	-	-	-	-	-
		3/4"	-	-	-	-	361	263	188	152	118	89	66	48	33	-	-	-	-	-	-	-	-
		1"	-	-	-	-	-	-	-	-	-	461	359	280	217	-	-	-	-	-	-	-	-
31, 37, 42 & 48	3 Row	3/4"	-	-	-	-	-	-	-	-	134	104	81	63	48	35	25	16	9	-	-	-	
		1"	-	-	-	-	-	-	-	-	-	526	422	341	277	221	177	141	111	-	-	-	
		1 1/4"	-	-	-	-	-	-	-	-	-	-	-	-	-	-	576	467	378	-	-	-	-
	4 Row	3/4"	-	-	-	-	-	-	-	-	126	97	75	57	43	30	19	11	4	-	-	-	-
		1"	-	-	-	-	-	-	-	-	-	497	397	319	257	200	156	120	90	-	-	-	-
		1 1/4"	-	-	-	-	-	-	-	-	-	-	-	-	-	-	514	405	315	-	-	-	-
60	3 Row	3/4"	-	-	-	-	-	-	-	-	121	92	69	51	37	23	12	3	-	-	-	-	
		1"	-	-	-	-	-	-	-	-	-	473	372	293	230	172	127	90	59	-	-	-	
		1 1/4"	-	-	-	-	-	-	-	-	-	-	-	-	-	-	430	318	228	-	-	-	-
	4 Row	3/4"	-	-	-	-	-	-	-	-	123	94	72	54	40	27	16	8	-	-	-	-	-
		1"	-	-	-	-	-	-	-	-	-	485	382	306	244	187	143	106	77	-	-	-	-
		1 1/4"	-	-	-	-	-	-	-	-	-	-	-	-	-	-	476	367	278	-	-	-	-

**Notes:**

- Line lengths are based on water only. To adjust maximum line lengths for glycol, divide length by the factors shown in **Table 2**.
- IMPORTANT:** Glycol should never be used in a potable water system.
- All lengths are based on closed loop systems.
- Line lengths within the shaded areas should not be used when a water heater is the source of heat. When using a boiler for these line lengths, excessive line temperature loss will occur and must be accounted for.
- Supply and return lines must be properly insulated to reduce temperature loss and to prevent freezing when passing through an unconditioned space.
- All lengths include (12) 90° short radius elbows. To adjust for extra or fewer fittings, use the factors in **Table 1**.
- Always use full flow ball or gate valves to minimize pressure drop.

**Table 1** Equivalent ft. of pipe

Pipe size	90° SR el	90° LR el	45° el	gate valve
1/2"	1.5	0.8	1	1
3/4"	2	1	1.4	1.4
1"	2.7	1.3	1.9	1.9
1 1/4"	3.6	1.8	2.5	2.5

**Table 2** Fluid Temperature

% Glycol	140° F	160° F	180° F
10	1.04	1.04	1.02
20	1.08	1.07	1.04
30	1.13	1.11	1.08
40	1.19	1.16	1.12
50	1.24	1.21	1.17

# Sizes 12 - 30, 36 Installation Configurations

Shading Indicates Proper Line Connections

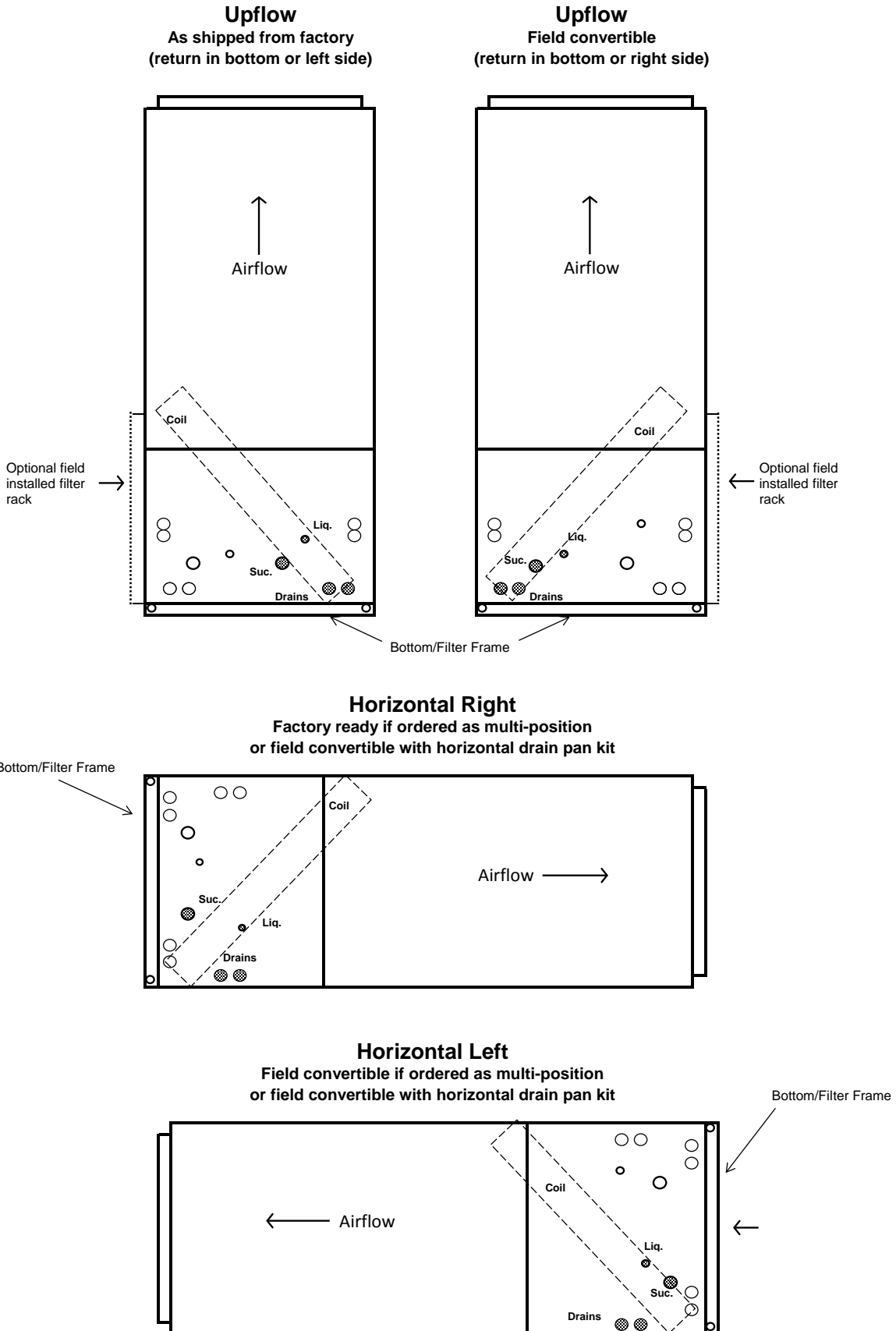



# Sizes 31, 37 - 60 Installation Configurations

Shading Indicates Proper Line Connections

**Upflow**  
As shipped from factory  
(return in bottom)

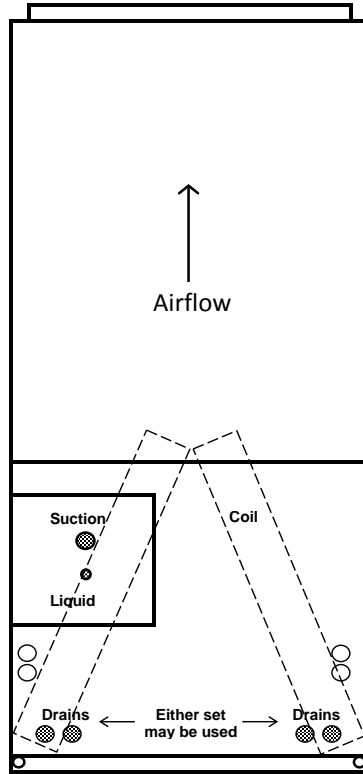

Bottom/Filter  
Frame

**Horizontal Right**  
Factory ready if ordered as multi-position  
or field convertible with horizontal drain pan kit

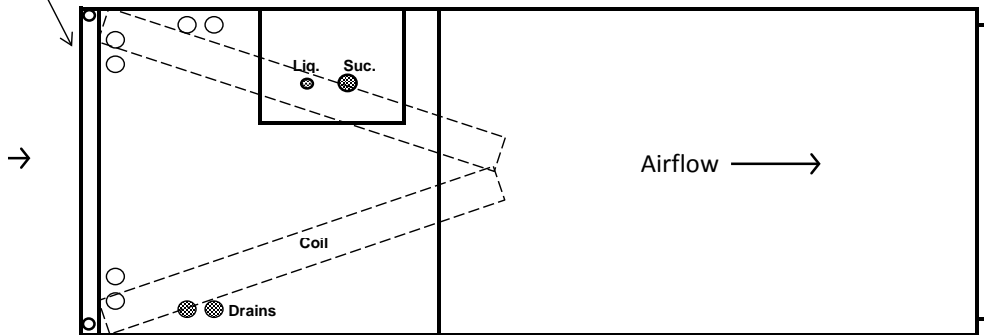

**Horizontal Left**  
Field convertible if ordered as multi-position  
or field convertible with horizontal drain pan kit

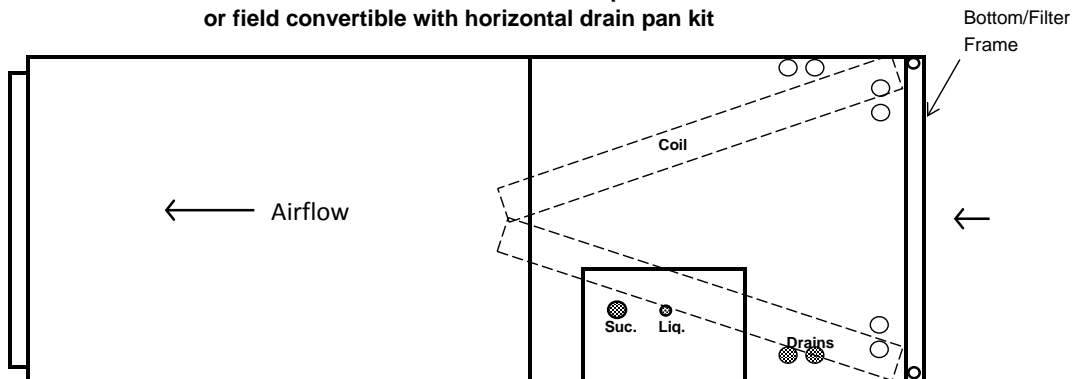

# Dimensions

## Sizes 12 - 30, 36

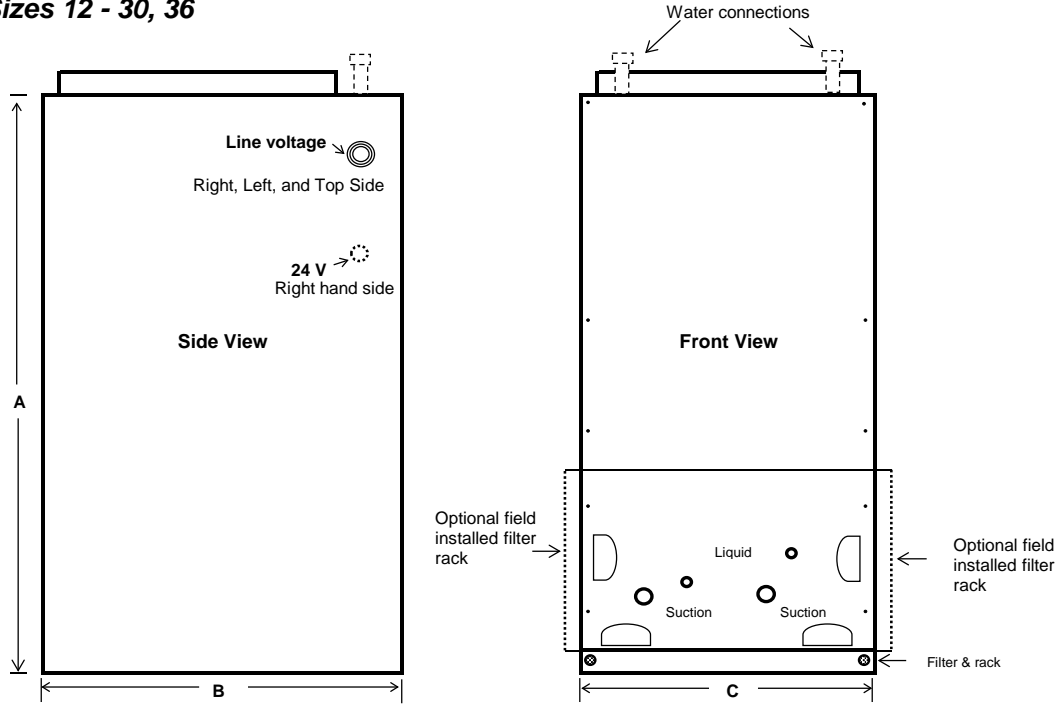

Unit Size	A	B	C	Supply Duct Opening		Return Duct Opening	
				Depth	Width	Depth	Width
12, 18 & 24	44"	22"	15"	17"	13 1/2"	20"	12 1/2"
25, 30 & 36	48"	22"	18 1/2"	17"	17"	20"	16"

## Sizes 31, 37 - 60

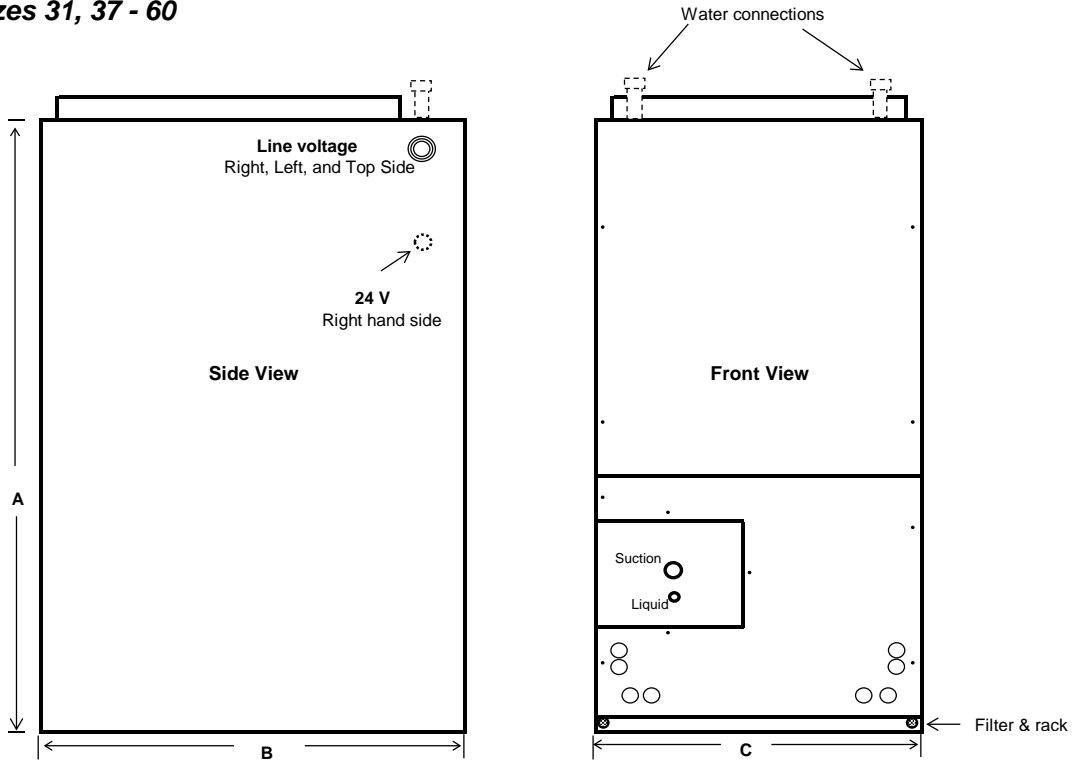

Unit Size	A	B	C	Supply Duct Opening		Return Duct Opening	
				Depth	Width	Depth	Width
31, 37, 42 & 48	49"	26"	20"	21"	18 1/2"	23 3/4"	17 1/8"
60	53"	26"	22"	21"	20 1/2"	23 3/4"	19 1/8"





---

2175 West Park Place Boulevard  
Stone Mountain, GA 30087  
[www.adpnow.com](http://www.adpnow.com)